

RAK8-MB Instruction Manual



For programming information: [Wireless RAK Programming guide](#) or [Wired system Programming Guide](#)

For general system information: [Wireless RAK Application Sheet](#) or [Wired RAK Application Sheet](#)

Overview:

The RAK8 Motherboard forms the base for up to 8 pluggable modules which can be added in any combination according to system requirements. Compatible pluggable modules to be used with the RAK8 motherboard are:

WMT-400 - 400W Trailing edge dimmer

WML-300 - 300W Leading edge dimmer

WDA-600 - 600W digital dimmer for use with 1-10V, DSI and DALI broadcast

WMS-600 - 600W Switching module

WM-CUB - Twin relay curtain and blind controller

RAK8s, combined with a Link device (RxLINK or RAK-LINK) can either be used as a single 8 channel unit or formed into a "stack". RAK8s can also be used in combined stacks with other RAK units (RAK4-T, RAK4-F, RAK4-R) on the same Link device.

Before commencing installation of a Rako product first read this instruction manual carefully. Rako Controls Ltd accepts no responsibility for any damage or injury caused by incorrect installation of a Rako product. Installation should only be carried out by a qualified electrician. Always install RAK units in a well ventilated room, with a minimum clearance of 50mm at the sides in the correct orientation i.e. vents top and bottom. Each RAK unit must be earthed.

Wireless system (RxLINK):

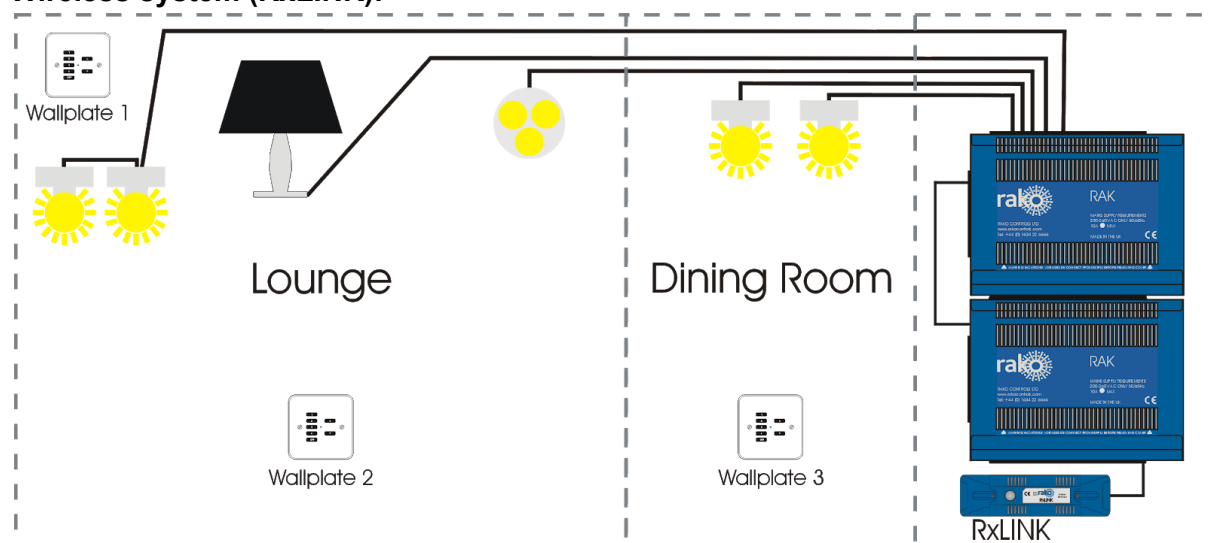

The RxLINK is used to integrate the RAK(s) into the wireless system and can support a total of 16 circuits. For example two RAK8s or one RAK8 and two RAK4s.

Wired system (RAK-LINK):

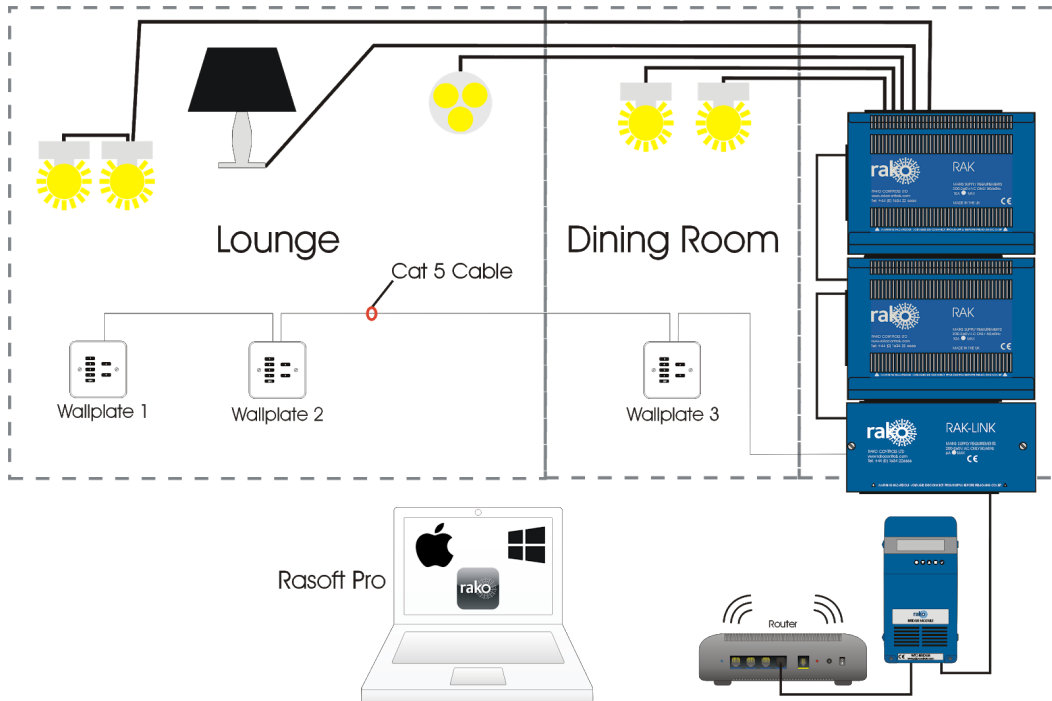

The RAK-LINK is used to integrate the RAK(s) into the Rako Wired Network and can support a total of 32 circuits. For example 4 RAK8s or 3 RAK8s and 2 RAK4s.

[The circuit board:](#)

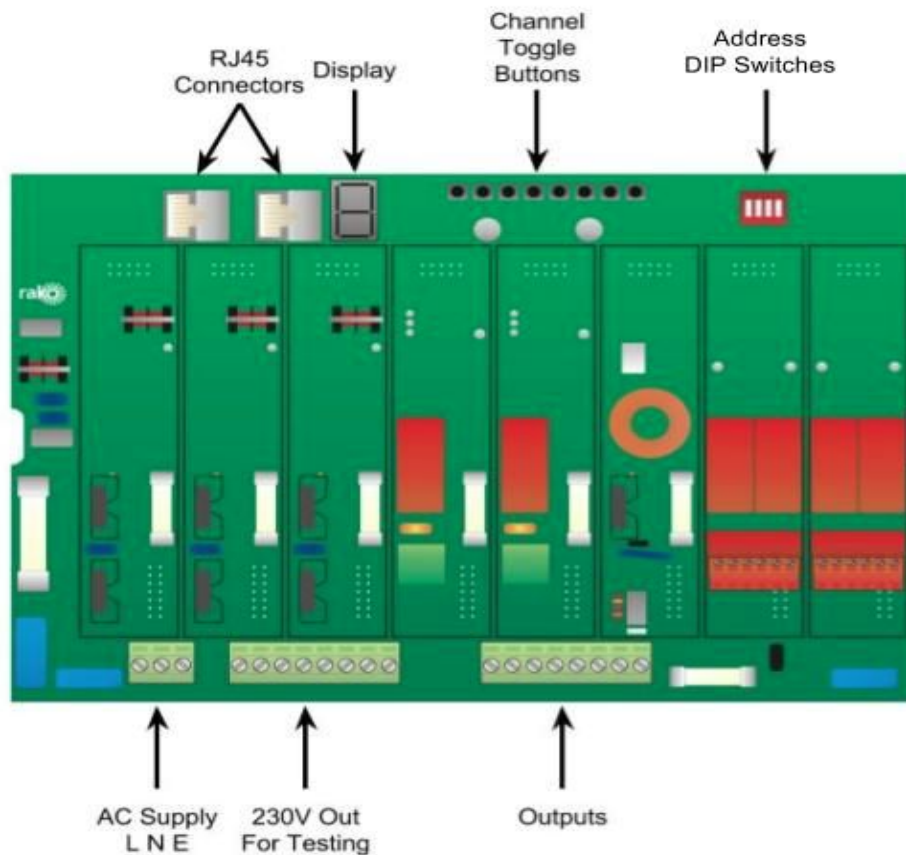

Installation:

POWER SHOULD BE ISOLATED THROUGHOUT THE INSTALLATION PROCESS

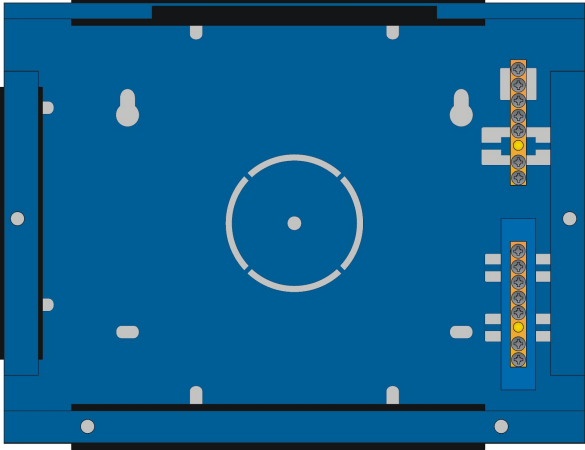
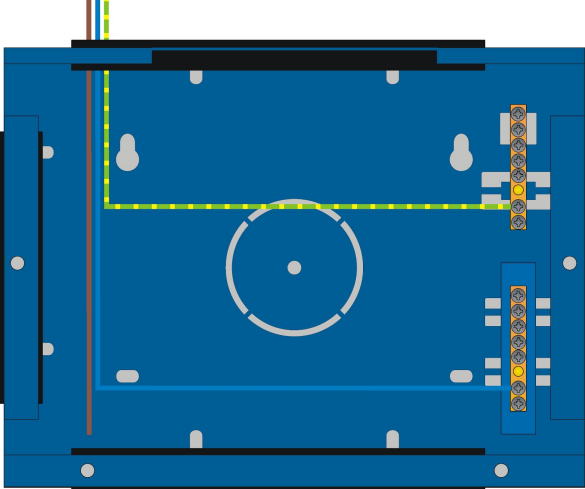
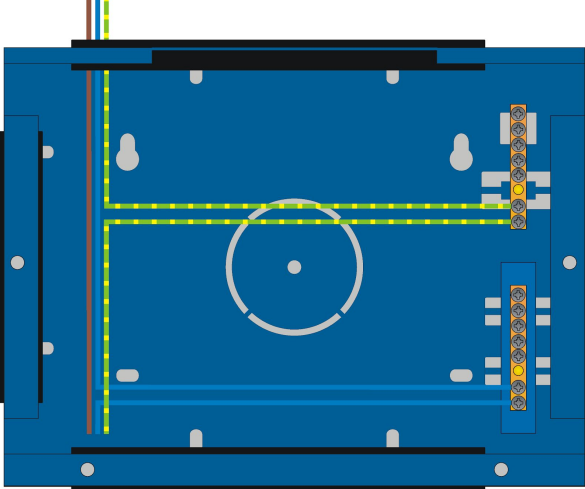
Step 1		<p>Secure metal box housing to wall or secure mounting position.</p> <p>The RAK system relies on being vertically mounted to allow the ventilation system to work properly.</p>
Step 2		<p>Bring a separate 10A protected supply to each RAK case.</p> <p>Connect the Neutral and Earth to the buzz bars as shown.</p> <p>Bring the live to the front of the metalwork ready for connection to the circuit board.</p>
Step 3		<p>Bring a single Neutral and Earth from the buzz bars to the front of the metalwork.</p> <p>Prepare screws on either side of metalwork ready to hold the circuit board. They should be present and screwed loosely into the case.</p>

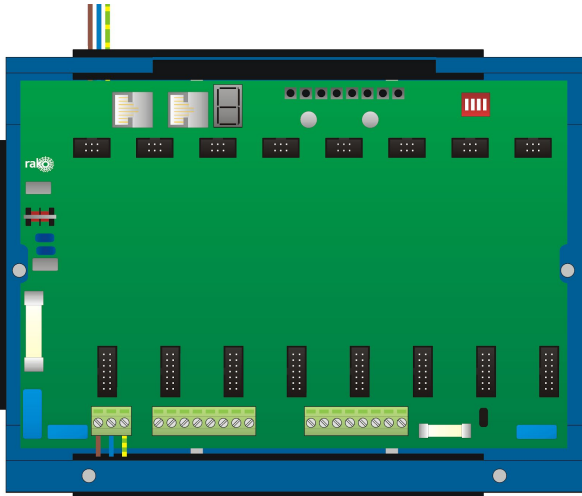
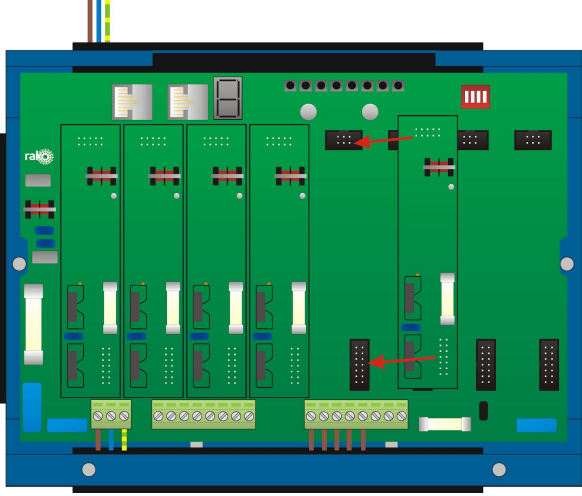
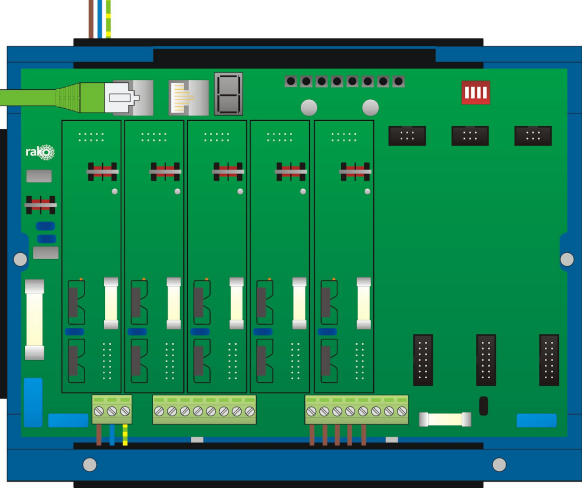
<p>Step 4</p>		<p>Place the circuit board on the two screw on either side of the metalwork.</p> <p>Do not screw down at this stage as the buzz bars need to be accessible for Neutral/Earth connections of lighting circuits.</p> <p>Connect Live, Neutral, Earth for board supply as indicated.</p>
<p>Step 5</p>		<p>Insert the daughterboards into the slots on the motherboard.</p> <p>Connect Neutral and Earth to appropriate buzz bars in the back of the casing</p> <p>Make Live load connections to the right hand 8 way terminal block as shown.</p> <p>NB In this example 5 slots of the RAK6-MB are used.</p>
<p>Step 6</p>		<p>Insert the RJ45 cable from the RAK-LINK/RxLINK into the port on the RAK and from there another RJ45 cable to each RAK in the "stack".</p> <p>Screw down the circuit board to secure it to the case and fit lid to complete installation</p> <p>NB The WDA-600 and WM-CUB will have connections on the circuits boards themselves which also need to be connected.</p>

Rako thanks you for having purchased a Rako product and hopes that you are pleased with your system. Should for any reason you need to contact us please contact us via our website www.rakocontrols.com or by phoning our customer help line on 01634 226666.



[Appendix: WM-CUB wiring diagrams](#)

Mains switching

The WM-CUB is most commonly used with “mains switching blinds”. The six way terminal block is fed with permanent mains and has two switched mains outputs. A three core and earth cable should be run from the WM-CUB to the blind.

24V Polarity switching

The WM-CUB can also be used to control 24V polarity switching blinds. In this case a separate 24V power supply is required and a two core cable should be run from the WM-CUB to the blind.

Contact Closure

The WM-CUB can be used to provide a control signal to the blinds. In this case a 3 core cable is run from the WM-CUB to the blind control box.



Mains Blinds wiring:

Terminal	Mains
1	Permanent Mains
2	Relay A Output (Open)
3	Linked to 4
4	Linked to 3
5	Relay B Output (Close)
6	Not used



24V Blind wiring:

Terminal	24V
1	Relay A Output (Open)
2	+24V from PSU
3	0V from PSU
4	Relay B Output (Close)
5	+24V from PSU
6	0V from PSU

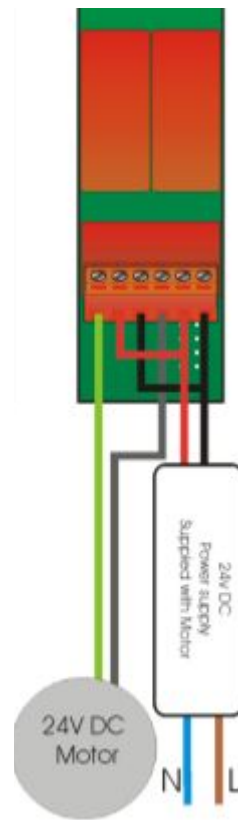

Contact closure blind wiring diagram:

Terminal	Contact Closure
1	Common
2	Relay A Output (Open)
3	Not used
4	Common
5	Relay B Output (Close)
6	Not used

