



Datasheet

RNC-XXX

Wireless NFC Programmable Keypad



What is the RNC?

The RNC is a wireless battery-powered keypad for transmitting Rako commands to wireless receivers such as the RMT-500 or RDA-800.

Available in a wide range of button configurations to control lights, blinds, and audio, the RNC provides a versatile solution to suit the needs of all room sizes.

The RNC is programmed using Rasoft Pro software in conjunction with a RAMPI or HUB via NFC and can be programmed to control multiple Rooms and Channels from a single RNC keypad.

RNC Button Layouts

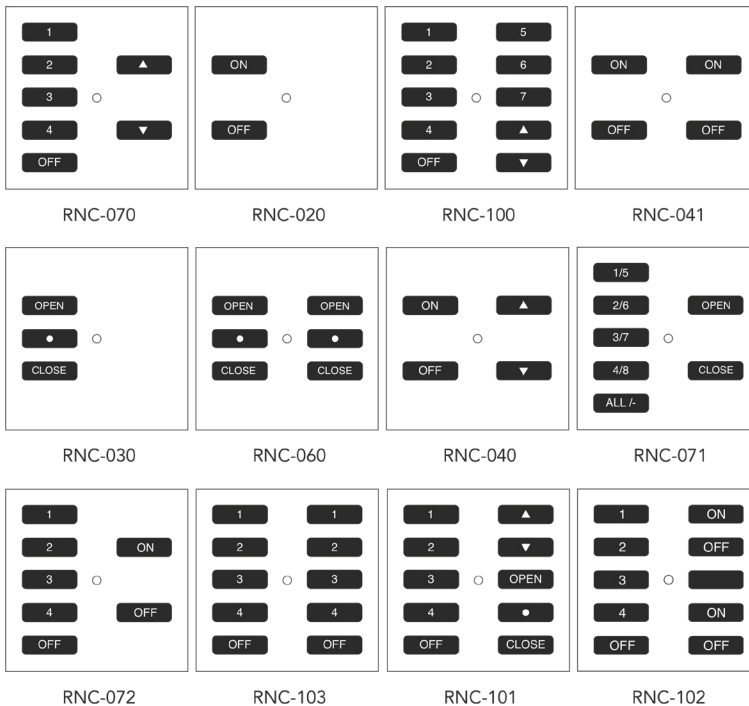

Technical Data

Dimensions	50x50x12
Fixing	Flush mounting into standard UK single gang back box, minimum 12mm depth.
	Surface mounting on standard single gang UK or European back box or direct to a flat surface.
Weight	100g
Input Supply	1 x CR2032 3V lithium coin cell battery
Climate Range	Temperature +2C to +40C Humidity +5% to 90% non condensing
Standards	RoHS UKCA, CE EN 60669-2-5:2016
Communication	FM radio, 433.9MHz

Installation and Setup

For information on installing and setting up the RNC, see the [RNC Manual](#).

Connections/Dimensions

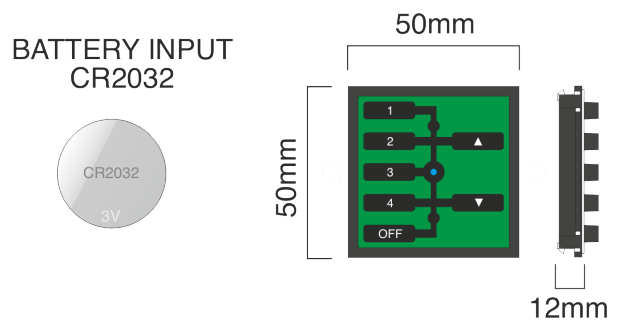

Document Version 2.0.1

telephone +44 (0) 1634 226666 | www.rakocontrols.com